



Part Number: 280-CA-EFIMEFI

MEFI-4B Adapter Harness for IQ3S, IQ3D, Universal CAN & Vantage EFI Interface module

Description:

This adapter harness is used to connect the MEFI unit to the Racepak IQ3S, IQ3D, Vantage CL1 or the Universal CAN module. Once connected and properly setup, data from the ECU is then available for use with the Racepak IQ3S, IQ3D, Vantage CL1 or the Universal CAN module to enable use of all Racepak V-Net devices including real time telemetry, and data logging applications.

J1939_MOD				
Channel #	Channel Name	V-Net ID #	EFI Variable	Units
1	Engine RPM	0x200	Engine Rpm	RPM
2	Man A.B.S. Press	0x20E	MPA	kPa (abs press)
3	Throttle Position	0x30B	Throttle Pos.	%
4	Man Temp	0x207	Manifold Air Temp	Deg F
5	Battery Volt	0x440	Battery Voltage	Volts
6	Water Temp	0x209	Engine Coolant Temp	Deg F
7	Oil Press	0x204	Engine Oil Press	PSI
8	Oil Temp	0x203	Engine Oil Temp	Deg F
9	Pump Press	0x305	Fuel Pump Press	PSI
10	A/F Cyl 1	0x310	Air/Fuel Ratio 1	AFR
11	A/F Cyl 2	0x311	Air/Fuel Ratio 2	AFR
12	Speed	0x3BC	Vehicle Speed	MPH
13	E1-Knock	0x530	Engine Knock	1=YES 2=NO
14	Man Press	0x206	Manifold Pressure	Inches Hg/PSIg
15	Fuel Flow	0x231	Fuel Consumption Rate	GPH

Harness Installation:

This adapter harness has been designed to connect directly to the MEFI CAN bus and is capable of monitoring up to 14 data channels within the MEFI controller. The data channels and their default configurations are shown above. The sensor ID's and default calibrations can be modified through the use of a PC and the DataLink data acquisition software.

Locate the 2 pin Deutsch connector found on main harness of the IQ3S, IQ3D or Racepak Universal CAN module. Plug pre-terminated 2 pin mating Deutsch of the adaptor harness into this connector. Route the wires from the adaptor harness to the MEFI wire harness. Since the type of connector required is dependent on the MEFI wire harness used, you will need to get this adaptor from your MEFI dealer. Avoid mounting near heat sources and high voltage ignition wires. Two additional pins are provided if you wish to shorten the adapter harness.

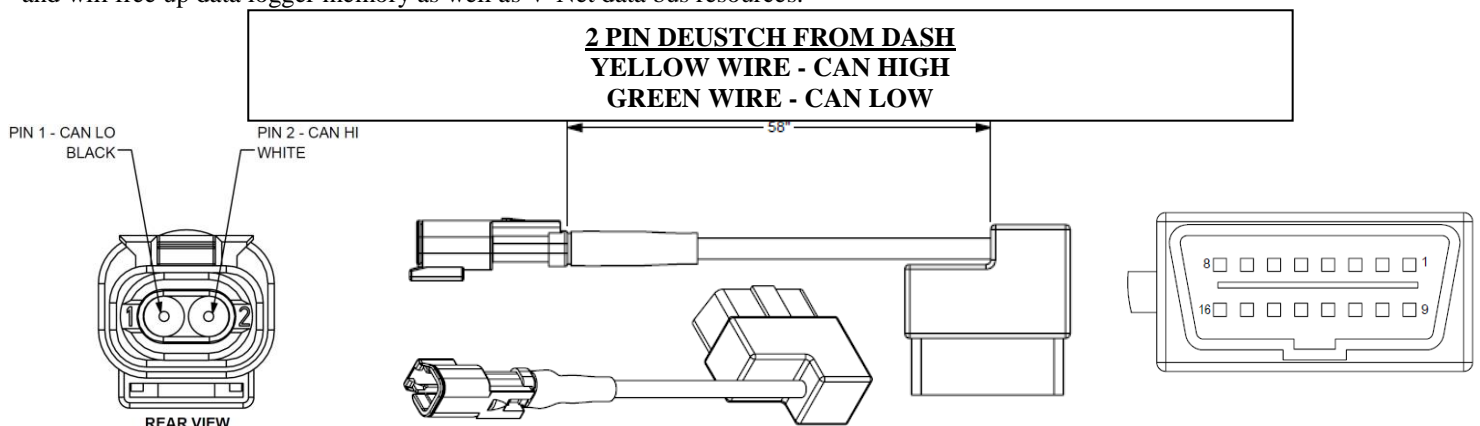

Please ensure the MEFI J1939 CAN bus data stream has been enabled and properly configured.

If sensor inputs to the MEFI unit are not being used the sample rate to that channel should be set to zero. This will disable the channel and will free up data logger memory as well as V-Net data bus resources.

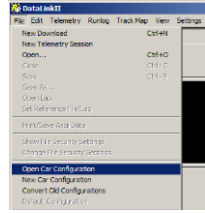
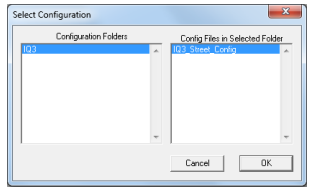

Configuration File Update (IQ3S Street Dash or IQ3D Drag Dash):

Before the channels from the ECU can be displayed on your IQ3S or IQ3D, you will need to update enable the ECU interface on the IQ3S dash, sync the channels into the configuration file and then program the selected channels to be displayed on the dash screen(s).

1. Connect PC to IQ3 Dash unit using the USB programming cable supplied with the IQ3 Dash unit system. The programming port is located on the rear of the IQ3 Dash unit.
2. Ensure the main power is turned on for the IQ3 Dash. The dash backlight will be on and lit when power is on.
3. Start the DatalinkII program by double clicking on the DatalinkII Program icon located on the Windows desktop of PC (shown right). 
4. Open the car configuration file. To open the car configuration file, select **File** located in the main menu bar across the top of the screen and select **Open Car Configuration**. (Shown right). 
5. The dialog box (shown lower right) will be displayed. 
6. The list on the left-hand side of the **Select Configuration** dialog box will display all of the file folders in the RacePakData subdirectory (C:\RacePakData) that contain valid configuration files with a .rcg file extension. Select the IQ3 listing by selecting with the cursor.
7. The list on the right will now contain the list of configuration files contained in this folder. The factory configuration file for the IQ3 Street and IQ3 Drag Dash units will be located here.
8. Once the proper configuration file has been selected, click the OK button.
9. The configuration file for the IQ3 is now open.
10. Click **Edit** on the menu bar and select **Read V-NET Config**.
11. A dialog box (shown right) may appear asking if you wish to make this configuration the default configuration file. If this is the only Racepak system you will be programming, select the top option to make it the default. If using this PC to program more than one Racepak system, select the second box. 
12. A message log will appear and should begin reading your system configuration.

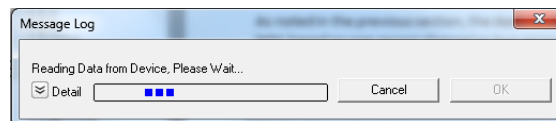

13. When finished the message log should display *****DEVICES READ SUCCESSFULLY*****.

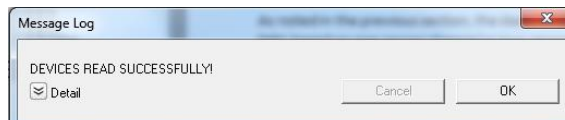

14. Click on the OK button.
 - a. If the ECU interface was turned on using the pushbuttons/Setup Mode 1 you should now see a new channel buttons (boxes) for each channel.
 - b. If the ECU interface was not previously enabled, you can do so using the pushbuttons/Setup Mode 1, and then repeat the Read process after which the new ECU channels will appear.
 - c. If the ECU interface was not previously enabled, you can do so using the DataLink Software,
 - i. navigate to the Dash Info tab by right clicking on the channel button labeled **IQ3 Street** or **IQ3 Logger**
 - ii. Select Dash Info tab, locate the listing ECU Type under the Custom Programming Options
 - iii. Click on ECU type and select your ECU from the drop down list on the right

- iv. Select Send Configuration
 - v. Exit the LCD Dash Configuration window to return to the main configuration window and repeat the Read process after which the new ECU channels will appear
15. Right click on any of the channel boxes to modify/change their parameters.
 16. Once any change is made, you must select **Send Configuration** to send change to the dash.
 17. The channels are now ready to be selected and programmed to the Display pages.

Programming the Display Pages

Right click over the IQ3 Street Channel Button for the IQ3S Street Dash, or the IQ3 Logger Channel Button for the IQ3D Drag Dash. This action opens the following window:

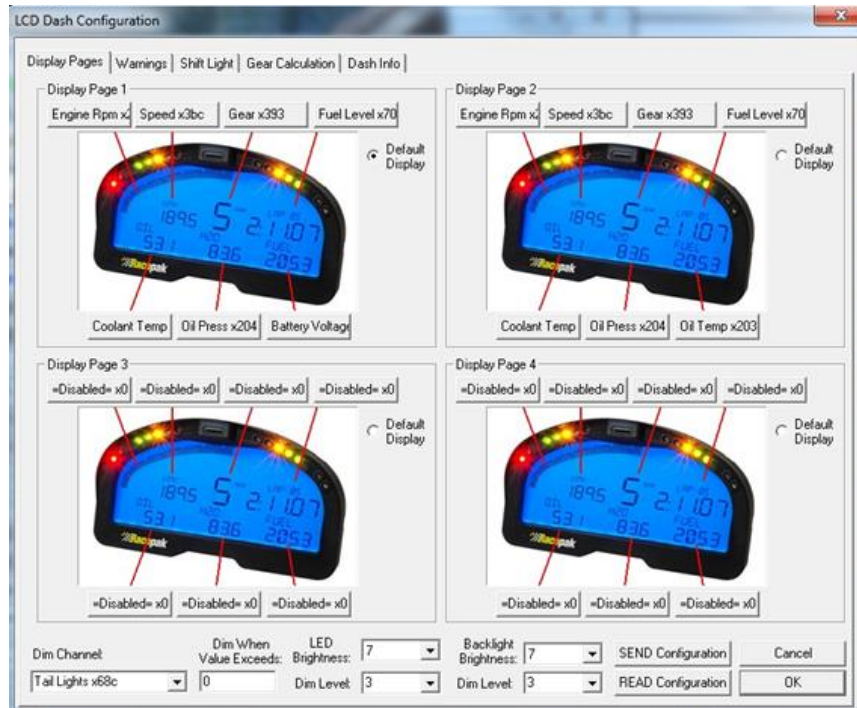

A view representing the current programming of all four display pages is obtained by selecting the Display Pages tab. Each input is programmed by selected the text box related to that input area, as indicated by the red line extending down to the dash, from each text box.

Bar Graph (Sweep Tach)

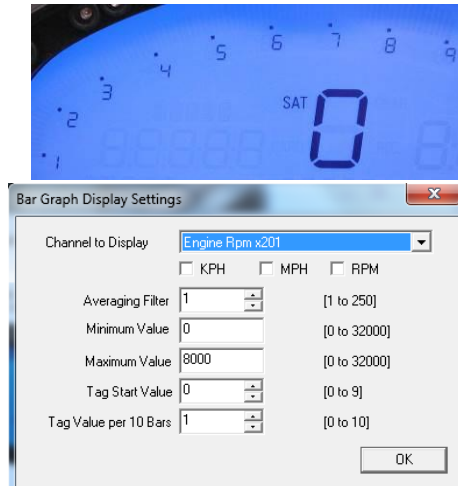

Function	Description
KPH MPH RPM	Selection defines channel name on dash
Channel to Display	Pull down arrow selects channel for bar graph data
Averaging Filter	Smooths displayed data. 10 is default
Minimum Value	Determines starting point for bar graph
Maximum Value	Determine ending point for bar graph
Tag Start Value	Determines start value for bar graph
Tag Value per 10 Bars	Determines value for each 10 bar segment. There are a total of 8, 10 bar segments for 80 total bars. Channel tag value must be equally divisible by the 80 bars to correspond correctly with a channels actual reading.
OK	Closes window following programming changes

Gear Indicator (center of dash) "Gear Position"

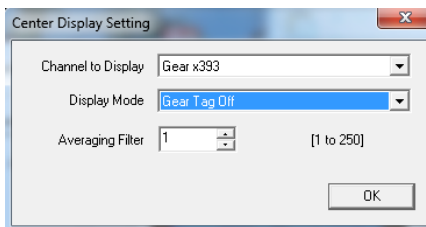

Function	Description
Channel To Display	Pull down arrow selects sensor channel
Averaging Filter	Smooths displayed data. 10 is default
Display Mode	Selects when to display the gear number in the center display.
OK	Closes window following programming changes

Remaining Inputs

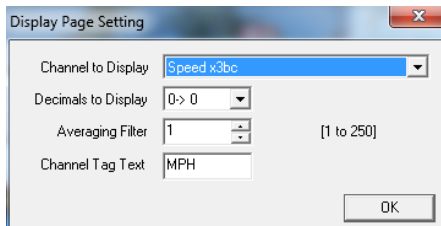

Function	Description
Channel to Display	Pull down arrow selects sensor channel
Decimals to Display	Number of digits to display after decimal
Averaging Filter	Smooths displayed data. 10 is default
Channel Tag Text	Name/channel label to be displayed. 5 total characters

As shown above, to program an input area, simply locate the desired sensor channel by use of the pull down arrow, select the sensor channel, then define the remaining values for Decimals to Display, etc.

Once the page is programmed as desired, select the SEND Configuration to send any changes to the dash. The dash should now represent the programmed parameters.

Configuration File Update (Racepak Universal CAN module):

Before the channels from the ECU can be displayed on your Racepak device, you will need to sync the channels into the configuration file and then program the selected channels to be displayed and or recorded.

1. Connect PC to the Racepak device using the appropriate programming cable supplied with the device.
2. Ensure the main power is turned on for the Racepak device.
3. Start the DatalinkII program by double clicking on the DatalinkII Program icon located on the Windows desktop of PC (shown right).



4. Open the car configuration file for the Racepak device you are intending to communicate with. To open the car configuration file, select **File** located in the main menu bar across the top of the screen and select **Open Car Configuration**. (Shown right).

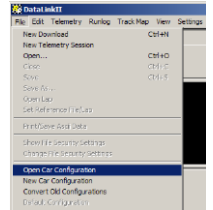

5. A dialog box will be displayed with a left and right pane.
6. The list on the left-hand side of the **Select Configuration** dialog box will display all of the file folders in the RacePakData subdirectory (C:\RacePakData) that contain valid configuration files with a .rcg file extension. Select the appropriate Racepak device.

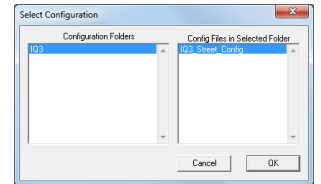

7. The list on the right will now contain the list of configuration files contained in this folder. Select the appropriate Racepak device you intend to communicate with and click the OK button.
8. The configuration file for the Racepak device is now open.
9. Click **Edit** on the menu bar and select **Read V-NET Config**.



10. A dialog box (shown right) may appear asking if you wish to make this configuration the default configuration file. If this is the only Racepak system you will be programming, select the top option to make it the default. If using this PC to program more than one Racepak system, select the second box.

11. A message log will appear and should begin reading your system configuration.

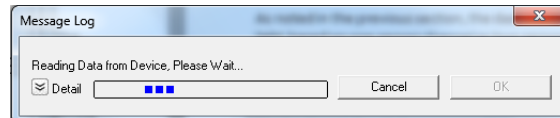

12. When finished the message log should display **DEVICES READ SUCCESSFULLY**.

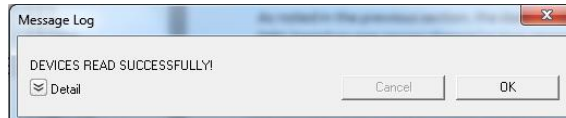

13. Click on the OK button.
14. If everything works properly, a new channel button named **ECU Type** will be added to the configuration file (shown right).
15. At this point, the particular ECU will have to be selected; you can do this by right clicking on the ECU Setup channel button.

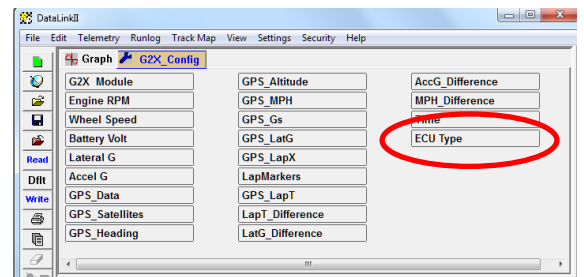

16. Locate and select the line listed in the Custom Programming Options window labeled ECU Type.

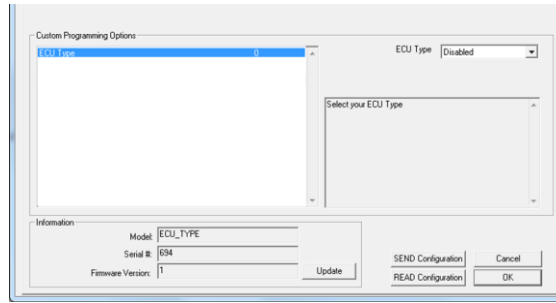

17. The drop down box to the right of the window can be clicked on and you will be able to scroll through the list of available ECU interfaces.

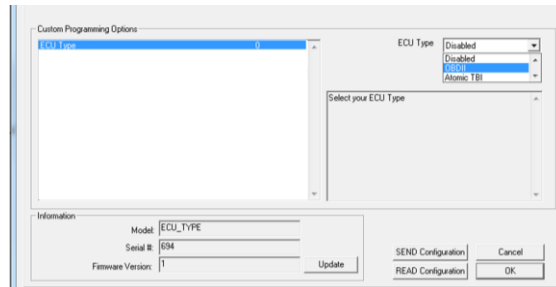

18. Select the ECU interface for the ECU you are connecting to.

19. Once selected, click the SEND Configuration button to program the Racepak Universal CAN module for that ECU.

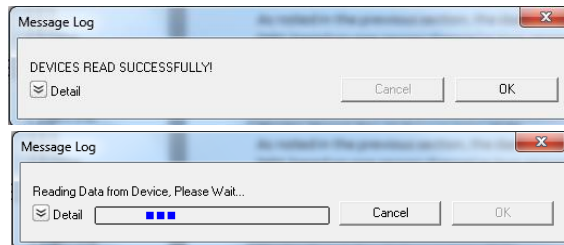

20. When finished the message log should display **DEVICES READ SUCCESSFULLY**.

21. Click on the OK button on the ECU window to go back the main channel listing window.

22. Channels boxes should now appear for each of the ECU channels. If the new channels are not present, select Read button on toolbar.

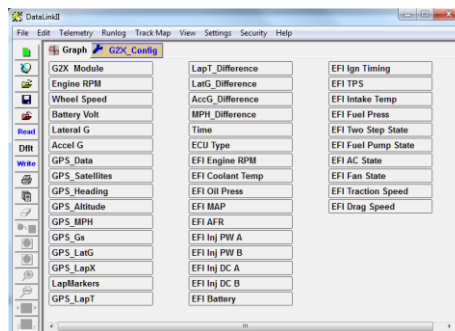

23. Final step is to save the updated configuration file. To do this, select File from the menu bar and click on Save. All programming is now complete. Turn power to the system off and then back on before its next use.

Vantage EFI Interface Module setup:

Please visit the Vantage CL1 site for instructions on how to setup your Vantage EFI Interface Module

<https://docs.racepak.com/cl1-v2/Track-Day/Vantage-OBD2-Module-Programming.pdf>

If you have any questions regarding warranty, please contact customer service at Racepak LLC. 949-709-5555



Racepak, IQ3 Street Dash, IQ3 Drag Dash, Vantage CL1 and V-Net are trademarks of Racepak LLC.
© Racepak LLC