

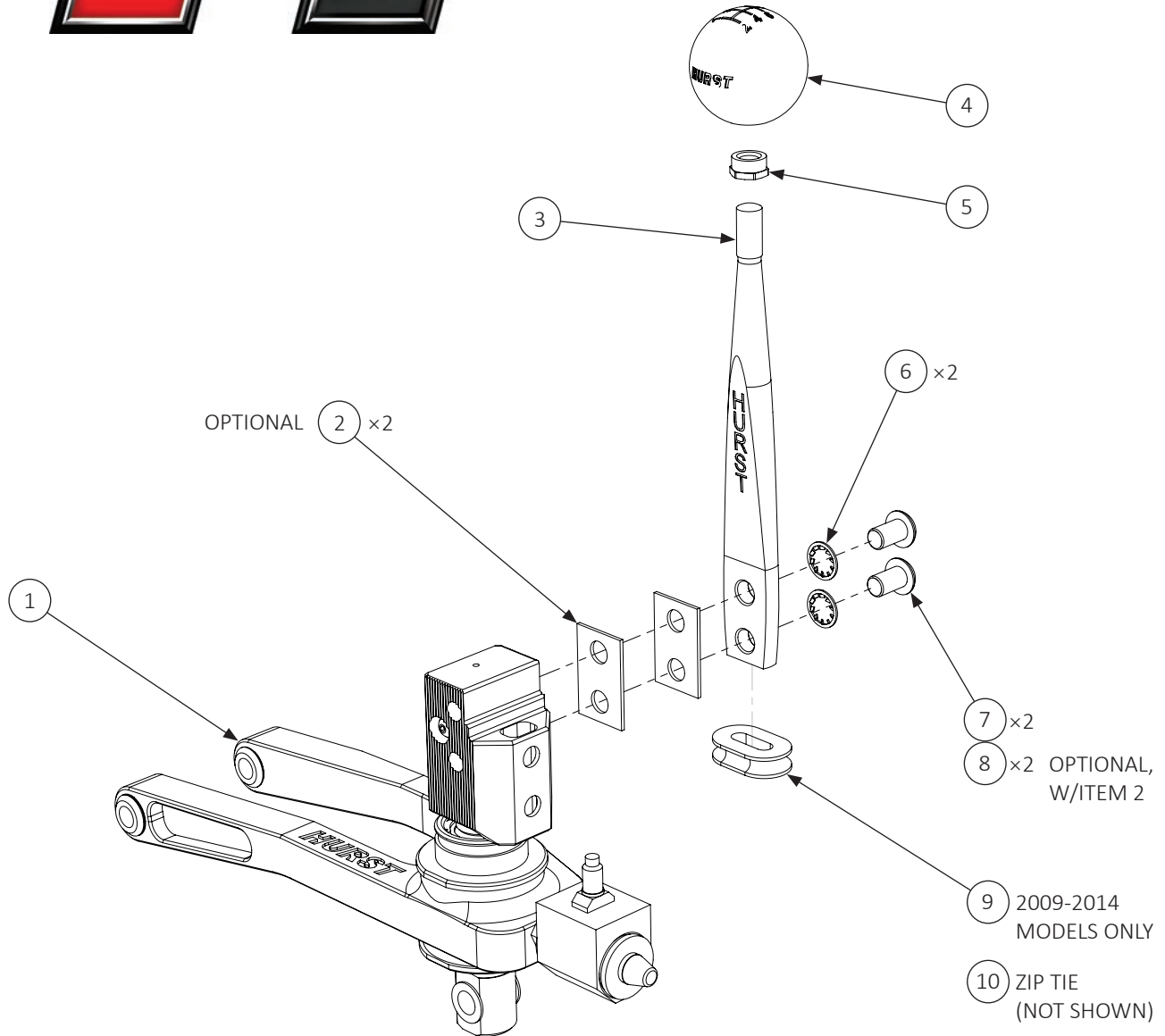

Instructions for **3916020** **BILLET/PLUS CLASSIC SHIFTER** for **2009–2020 DODGE CHALLENGER**



ITEM NO.	PART NO.	DESCRIPTION	QTY.
1	3916020-39	SHIFTER ASSEMBLY	1
2	2288521	ISOLATOR, NEOPRENE	2
3	2387238	STICK, SHIFTER, FLAT BAR, BOLT-ON, 7.5"	1
4	1636030	KNOB, WHITE, 6-SPD, HURST LOGO, 3/8-16 THREAD	1
5	1794719	NUT, LOCK, 3/8-16	1
6	2673533	WASHER, 3/8" ID INTERNAL LOCK (SINGLE-USE ONLY)	4
7	2156020	SCREW, 3/8-24 × 5/8" BH CAP BLACK	2
8	2158817	SCREW, 3/8-24 × 3/4" BH CAP BLACK	2
9	1140015	BOOT SUPPORT, RUBBER	1
10	5000250	ZIP TIE, 6" [NOT SHOWN]	1

REVIEW THESE INSTRUCTIONS AND VERIFY THE KIT CONTENTS

1. Before starting, take a moment to read and understand these instructions for your Hurst Billet/Plus shifter.



2. Use the parts drawing and list to verify your kit's contents. In the unlikely event that any parts are missing, please contact Hurst Technical Support for replacements.

REQUIRED SUPPLIES

- Medium strength thread-locking fluid (Permatex Blue or similar)

NOTES

- Installation of this kit requires average mechanical knowledge and skills, and no special tools. If this job is beyond your abilities, seek the services of a qualified technician.
- Retain all factory parts.
- The shifter mechanism is precision-assembled at our factory. **Attempted disassembly or modification of the shifter voids the warranty,** and may cause it to malfunction.
- If you do not understand any part of these instructions, please call Hurst Technical Support for assistance: (866) 464-6553.

SAFETY WARNINGS

- Perform this installation with the vehicle parked on a clean, level surface.
- Turn off the ignition, and set the parking brake or chock the wheels to prevent the vehicle from moving when the gearshift is manipulated.

REMOVE THE STOCK SHIFTER

2009-2014 MODELS:



3. Use a trim removal tool to carefully separate the console trim bezel from the console cover. Then lift the bezel slightly to see the shifter stick screws.



4. Remove the 2 shifter stick screws. Then remove the assembled stick, boot, and trim bezel from the vehicle.



5. Carefully unsnap the console cover from the console, then tilt it sideways to see the electrical connectors underneath.

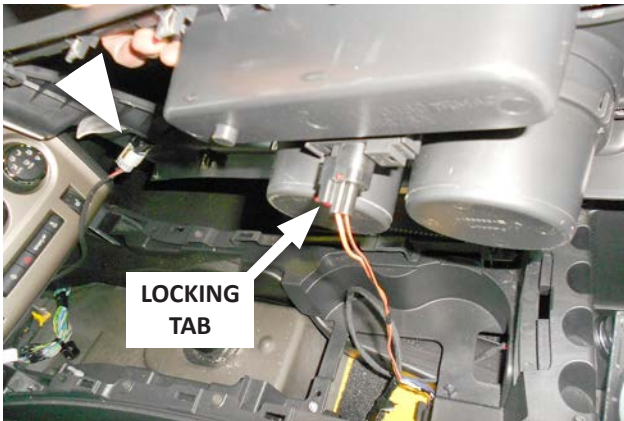

6. Remove the electrical connectors at the 12 volt outlet and the cup holder light. (Pull the red tab at the cup holder to unlock the connector.) Then remove the console cover from the vehicle.



9. Remove the electrical connector located in the left side of the console.



7. Remove the 2 screws at the front of the center console base.

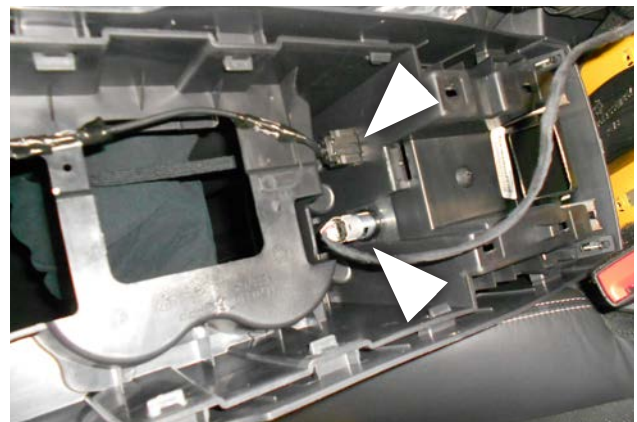

10. Carefully tilt the console to see underneath. Remove the electrical connectors at the 12 volt outlet and the USB jack. Then remove the console from the vehicle.

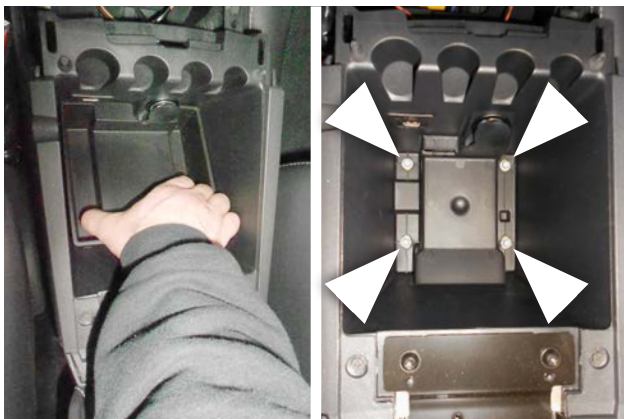

8. Remove the plastic liner from the bottom of the center console storage compartment, then remove the 4 screws.



11. Lift the rear of the vent duct up sharply to release it. Then move the duct rearward to disengage its front end, and remove it from the vehicle.



12. Detach the harness clamp from the button on the front of the dust boot.

Go to Step 21.

2015-2020 MODELS:



13. Use a trim removal tool to carefully separate the console bezel from the console.



14. Tilt the bezel slightly, and remove the control panel electrical connector.



15. Remove the 2 shifter stick screws. Then remove the assembled stick, boot, and console bezel from the vehicle.

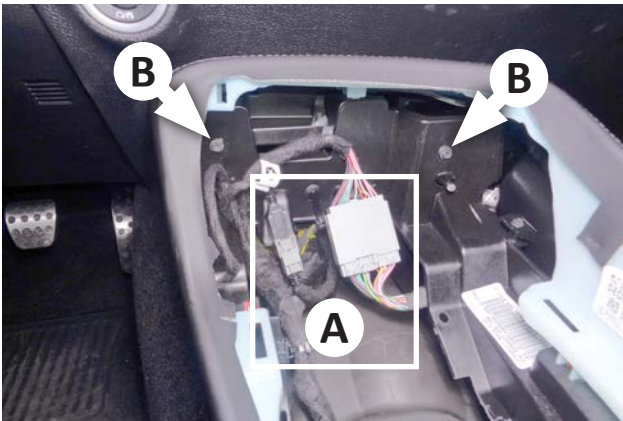

16. Separate the 2 electrical connectors (A). Then remove the 2 screws (B) at the front of the console base.



19. Lift the rear of the vent duct up sharply to release it. Then move the duct rearward to disengage its front end, and remove it from the vehicle.



17. Move both front seats fully forward. At the bottom rear on each side of the console, remove the square trim cover and the screw beneath it (2 screws total).



20. Detach the harness clamp from the button at the front right of the dust boot.



18. Move both front seats fully rearward, then carefully remove the center console from the vehicle.

ALL MODELS:



21. Fold the dust boot up and forward to access the tunnel cover fasteners.



22. Remove all 7 nuts from the tunnel cover (1 to the rear of the shifter seal, and 6 along the sides).



23. Push the edges of the shifter seal down and in to separate it from the tunnel cover.



24. Remove the tunnel cover from the vehicle.

NOTE: It may be necessary to carefully use a screwdriver or trim removal tool to break the surface tension at the cover gasket.



25. Remove the screw connecting the dog-bone link to the shifter.

NOTE: The screw will be tight because of thread-locking fluid used at assembly.



26. Rotate the locking tabs on the 2 shifter yoke pins clockwise until they face rearward, then remove the pins.

CAUTION: Do not break the tabs off the pins.



NOTE: A small screwdriver or dental pick may be necessary to rotate the locking tabs.



27. Remove the shifter assembly from the vehicle.

ASSEMBLE AND INSTALL YOUR HURST BILLET/PLUS SHIFTER

ALL MODELS:



28. Remove the lower shifter seal.

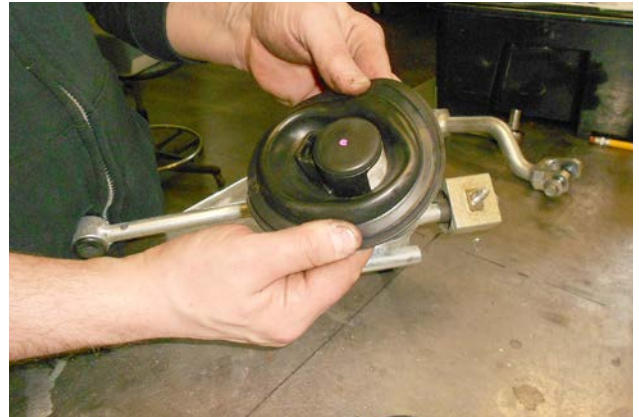

29. Remove the upper shifter seal.



30. Carefully pull the upper seal over the block on the shifter assembly (Item 1). Fit both seal lips into their grooves on the shifter, and orient the flat on the seal flange toward the rear.



31. Pull the lower seal over the bottom of the shifter assembly. Fit the seal lip into its groove on the shifter.

A NOTE ABOUT THE REAR BUSHING ASSEMBLY

The Hurst Billet/Plus shifter has been designed primarily as a competition or race shifter. In order to give the driver the most direct “feel” for the transmission possible, the shifter eliminates the isolating characteristics of the OEM shifter.

However, this may increase the noise, vibration and harshness (NVH) perceived by the driver and passengers. While Hurst has made every effort to minimize the NVH transmitted to the passenger compartment, some vehicles may transmit more NVH than others.

For this reason, **Hurst recommends installing the shifter with the OEM rear bushing assembly, as described in Step 32, for “daily driver” / non-competition use.** This should minimize NVH as much as possible, while still providing a greatly improved “feel” over the OEM shifter.

Of course, **the included Hurst rear bushing will provide the ultimate “feel” for competition use,** though with the possible trade-off of an increase in perceived NVH.

Lastly, please note that this kit includes 2 neoprene isolation pads to further reduce NVH, if desired. Installation of the pads is described at the end of these instructions.

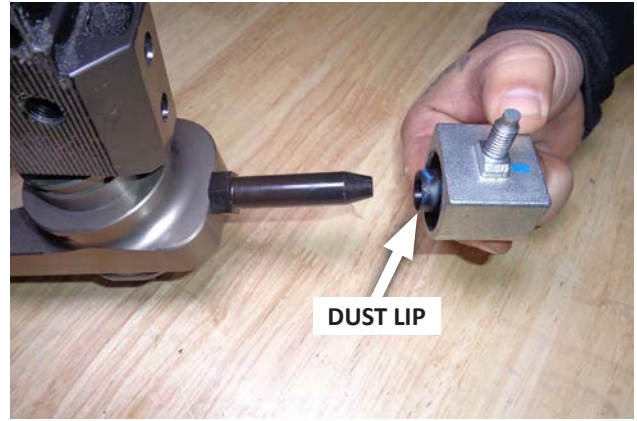

32. If desired, remove the rear bushing assemblies from both the OEM and the Hurst shifters, then install the OEM bushing on the Hurst shifter, with its dust lip toward the shifter. (Retain the Hurst bushing.)



33. Insert the ends of the shifter yoke into their respective clevis ears on the transmission.



34. Insert the 2 locking pins with the lock-tab flats facing rearward, then rotate the lock-tabs 1/4 turn counter-clockwise (left tab to the top, right tab to the bottom).

CAUTION: Do not break the tabs off the pins.

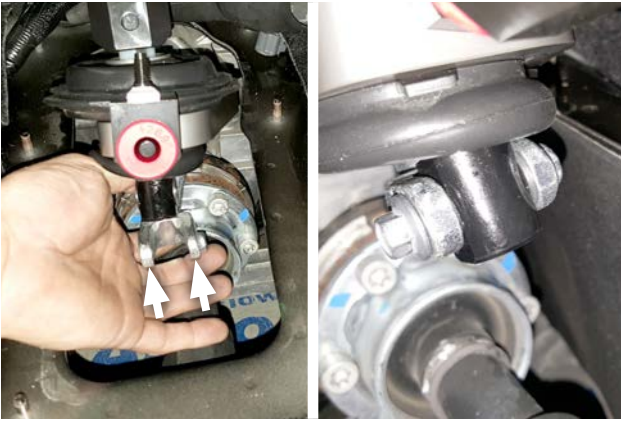

35. Connect the dog-bone link to the shifter using the stock screw with thread-locking fluid. Tighten the screw to 15 lb-ft torque.



38. Lower the dust boot over the tunnel cover, and tuck it under the edges of the carpet.

**For 2009-2014 models, go to Step 39.
For 2015-2020 models, go to Step 48.**



36. Reinstall the tunnel cover. Hand-start the 7 cover nuts, then tighten them to 15 lb-ft torque.



37. Secure the upper shifter seal to the tunnel cover by pulling its top flange up through the tunnel cover opening.

2009-2014 MODELS:

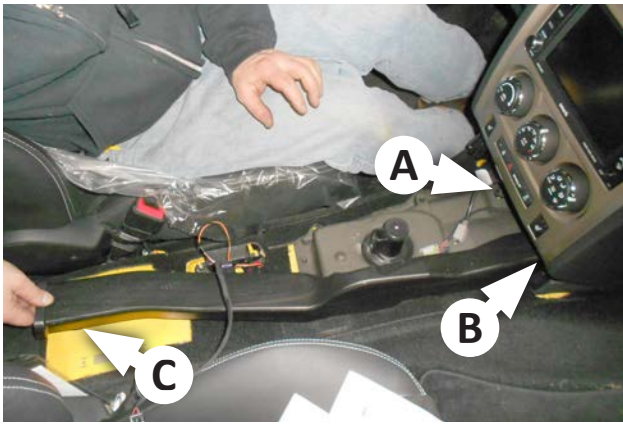

39. Push the harness clamp onto its button on the dust boot (A). Then insert the front of the vent duct into its opening (B) under the control panel, and snap it into place at the rear (C).

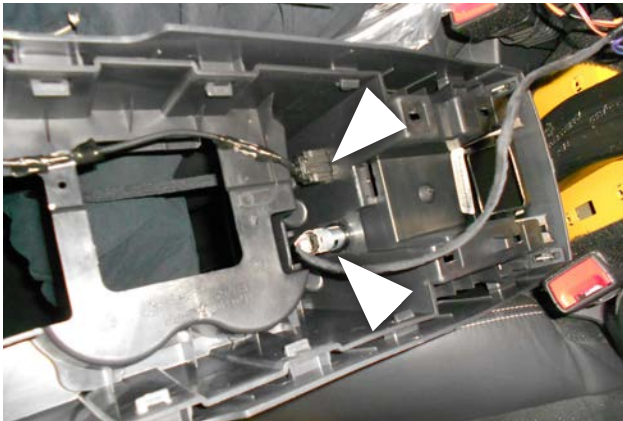

40. Carefully return the center console to the vehicle, tilt it slightly, and reconnect the 12 volt outlet and the USB jack.



41. Rotate the console to upright and put it in its final location. Be sure that the rear of the vent duct mates correctly with the opening at the rear of the console. Then reconnect the wires in the left side of the console.



42. Hand-start the 2 front console screws.

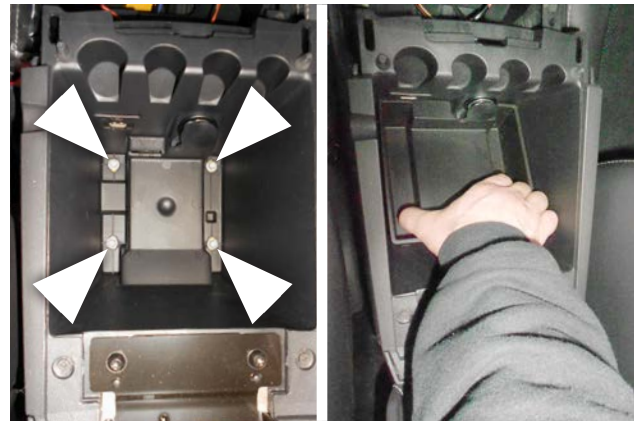

43. Hand-start the 4 rear console screws in the storage compartment. Tighten all 6 console screws (2 front and 4 rear), then reinstall the plastic liner in the storage compartment.



44. Return the console cover to the vehicle, and reconnect the wires to the 12 volt outlet and the cup holder light. Lock the cup holder light connector by pushing the red tab closed.



45. Snap the console cover into the center console.

OPTIONAL: TO USE THE OEM SHIFTER HANDLE
To install the Hurst shifter handle, go to Step 56.



46. Hold the assembled trim bezel, boot, and stick above the console cover, and insert the stick in the slot on the rear of the shifter. Install the 2 OEM screws with thread-locking fluid, then tighten them to 20 lb-ft torque.



47. Snap the trim bezel back into the console cover.

Congratulations, the installation of your Hurst Billet/Plus Shifter and OEM handle is complete.

2015-2020 MODELS:



48. Push the harness clamp onto its button on the dust boot.



49. Insert the front of the vent duct into its opening (A) under the control panel, and snap it into place at the rear (B).



50. Carefully return the center console to the vehicle and place it in its final location. Be sure that the rear of the vent duct mates correctly with the opening at the rear of the console.

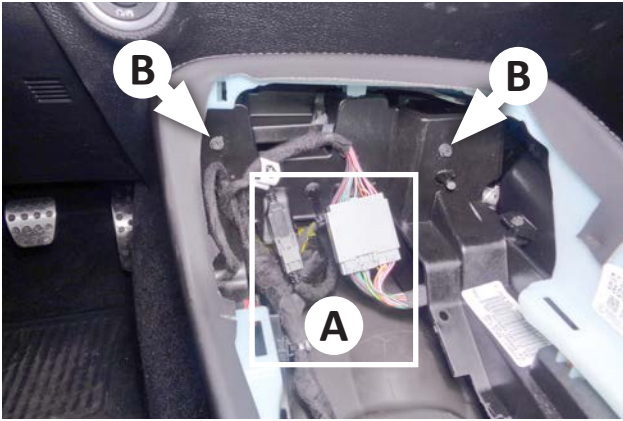

51. At the front of the console, reconnect the 2 wires (A). Then hand-start the 2 screws (B).



52. Move both front seats fully forward. Hand-start the 2 rear console screws. Tighten all 4 console screws (2 front and 2 rear), then reinstall the 2 square trim covers over the rear screws.

OPTIONAL: TO USE THE OEM SHIFTER HANDLE
To install the Hurst shifter handle, go to Step 64.



53. Reconnect the electrical wiring to the back of the control panel.



54. Hold the assembled console bezel, boot, and stick above the console, and insert the stick in the slot on the rear of the shifter. Install the 2 OEM screws with thread-locking fluid, and tighten them to 20 lb-ft torque.



55. Snap the console bezel into the console.

Congratulations, the installation of your Hurst Billet/Plus Shifter and OEM handle is complete.

**TO USE THE HURST SHIFT HANDLE ON
2009-2014 MODELS:**



56. Turn the boot inside out. Carefully remove the plastic locking ring from the shift handle, then remove the handle from the boot.



57. Push the **boot support (9)** onto the **shifter stick (3)**, until it is just clear of the alignment grooves.



58. With the boot still inverted, insert the shifter stick through the boot opening, with the alignment grooves facing left (the driver side).



59. Use the **zip tie (10)** to secure the boot to the boot support. When the zip tie is fully tightened, trim off the tail.



60. Hold the trim bezel above the console cover. Then fasten the shift handle to the **RIGHT (passenger)** side of the shifter block using **two 5/8"-long screws (7)** with thread-locking fluid, and **two lock washers (6)**.



61. Snap the trim bezel into the console cover.



62. Thread the **lock nut (5)** fully onto the stick (wrench flats down), followed by the **shifter knob (4)**.



63. Align the knob's shift pattern as desired, then tighten the jam nut.



Congratulations, the installation of your Hurst Billet/ Plus Shifter and Classic Handle is complete!

TO USE THE HURST SHIFT HANDLE ON 2015-2020 MODELS:



64. Fasten the **shifter stick (3)** to the LEFT (driver) side of the shifter block using **two 5/8"-long screws (7)** with thread-locking fluid, and **two lock washers (6)**.

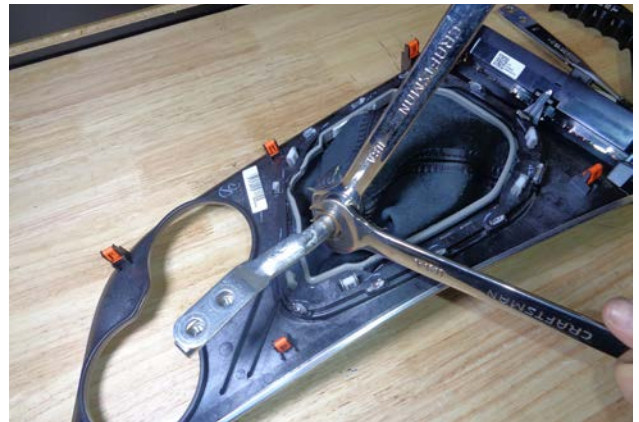

65. Turn the console bezel and boot upside down, and use 2 wrenches to loosen the shift handle jam nut.



66. Unthread the stick and jam nut from the handle.



67. Carefully separate the elastic boot opening from the bottom of the shifter handle.



70. Snap the console bezel into the console.



68. Move the console bezel into the vehicle, and carefully slide the boot opening down over the top of the shifter stick.



71. Thread the **lock nut (5)** fully down the stick (wrench flats down), followed by the **shifter knob (4)**. Then align the knob's shift pattern as desired, and tighten the jam nut.



69. Reconnect the electrical wiring to the back of the control panel.



Congratulations, the installation of your Hurst Billet/Plus Shifter and Classic Handle is complete!

USE OF THE NEOPRENE HANDLE ISOLATORS

Use of the neoprene shift handle isolators may help further reduce NVH. Since every vehicle's NVH profile is unique (due to differing harmonics, and varying vehicle, driving, wear, and atmospheric conditions), this method may be more effective in some vehicles than others. And it may not completely eliminate NVH to the satisfaction of all customers.

NOTES

- This modification should only be performed if using the OEM rear bushing was insufficient to eliminate noise.
- This method is not intended to mask problems with the transmission, clutch or related components, or with engine components that may have been modified.
- Do not install the neoprene isolators if you will use your vehicle in racing or competitive driving, as quality of shift feel may be diminished.
- Periodic inspection of the handle-shifter screws for tightness is recommended.



72. Remove the console bezel as required to access and remove the 2 shift handle screws.

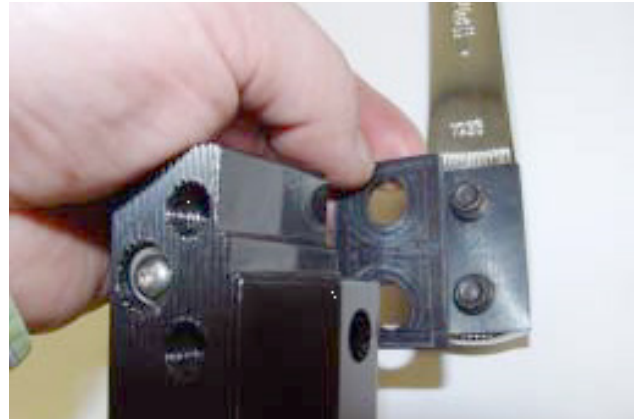

73. Reinstall the handle on the shifter block using the **two neoprene isolators (2)**, the **two 3/4"-long screws (8)** with thread-locking fluid, and **two NEW lock washers (6)**. (Do not reuse the previous lock washers.) Then reassemble shift boot and console bezel.

RETAIN THESE INSTRUCTIONS FOR FUTURE REFERENCE

Hurst Performance maintains a highly-trained technical service department to answer your technical questions, provide additional product information and offer various recommendations. Direct all technical issues and warranty questions to:

Hurst Performance
Phone: (866) 464-6553

www.hurst-shifters.com

