



# Installation Instructions

## 615116

1999-04 CHEVY#GMC 1500 TFI 7?G& SUVG  
4.8L~5.3L Engine

This kit is not designed to fit vehicles with a body lift.

NOT LEGAL FOR SALE OR USE ON ANY POLLUTION-CONTROLLED MOTOR VEHICLE IN CALIFORNIA OR IN STATES THAT HAVE ADOPTED CALIFORNIA EMISSION PROCEDURES.

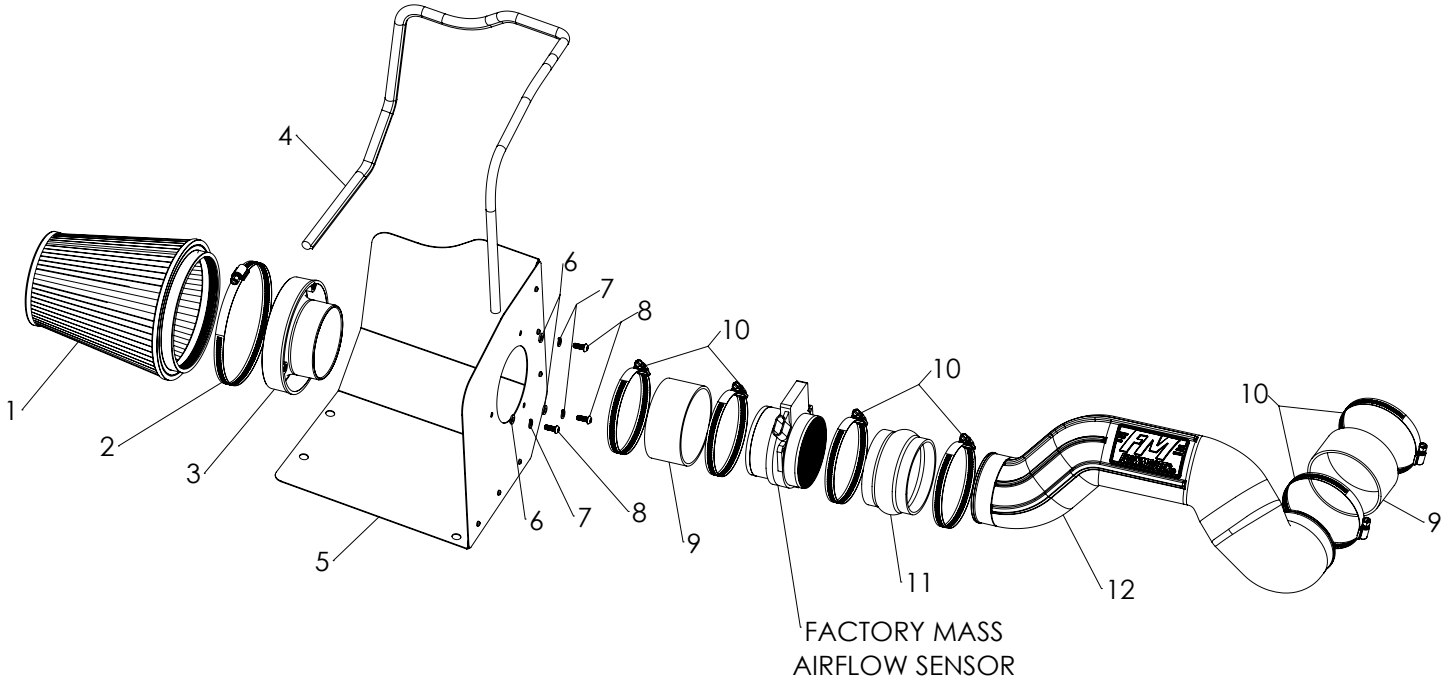

REV. 2/3/2020

ITEM NO.	PART NUMBER	DESCRIPTION	QTY.
1	AF1001	AIR FILTER, 8-5/8" x 6" DIA	1
2		SCREW CLAMP, #104 (4-1/8" - 7")	1
3	AF6002	ADAPTER, AIR FILTER, 4" x 6"	1
4	49000061	GASKET, HEAT SHIELD	48"
5	AF3002	HEAT SHIELD, 99-04 GM 1500 4.8L, 5.3L	1
6	HW319	FLAT WASHER, M6	3

ITEM NO.	PART NUMBER	DESCRIPTION	QTY.
7	HW318	LOCK WASHER, M6	3
8	HW244	SCREW, M6 x 1.0 x 16MM	3
9	AF4004	COUPLER, STRAIGHT 4" I.D. x 2" L	2
10	MC400H	SCREW CLAMP, #64 (3-9/16" - 4-1/2")	6
11	AF4046	COUPLER, FLEX 3-3/4" I.D. x 2-1/2" L	1
12	AF2027	INTAKE TUBE, 99-04 GM 1500 4.8L, 5.3L	1

**REVIEW THE INSTRUCTIONS AND VERIFY THE KIT CONTENTS:**

1. Please take a moment to read and understand these instructions before installing your Flowmaster cold air intake kit.



2. Use the parts drawing and list (front page) to verify your kit's contents.

In the unlikely event that any parts are missing, please contact FLOWMASTER Technical Support for replacements.

**REMOVE THE FACTORY AIR INTAKE SYSTEM:**

**NOTES**

- We highly recommend that you retain all factory air intake system parts.
  - Please refer to vehicle manufacturer's recommendations regarding removal of factory components.
  - Disconnecting the negative battery cable erases pre-programmed electronic memories. Write down all memory settings before disconnecting the negative battery cable. Some radios will require an anti-theft code to be entered after the battery is reconnected. The anti-theft code is typically supplied with your owner's manual. In the event your vehicle's anti-theft code cannot be recovered, contact an authorized dealership to obtain your vehicle's anti-theft code.
3. Turn off the vehicle's ignition and disconnect the negative battery cable.



4. Remove the bolt and the engine appearance cover.

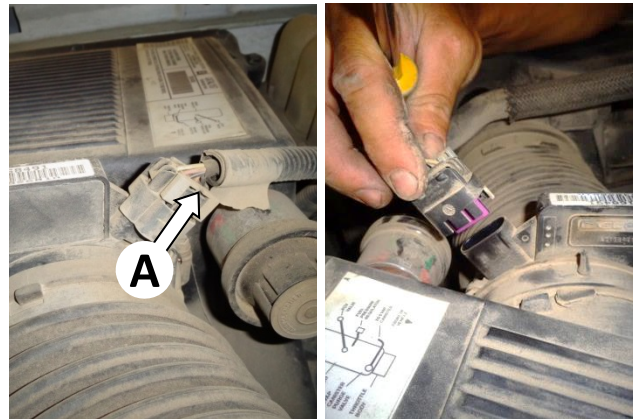

5. Disconnect the mass airflow (MAF) sensor plug by pulling the locking tab (A) away from the sensor until it stops, then pulling the plug straight off the sensor.



6. Use a flat-tip screwdriver to disconnect the coolant hose clamps from the air intake duct.





7. Loosen the screw clamp securing the intake duct to the throttle body.



8. Loosen the screw clamp securing the MAF sensor to the airbox.



9. Disconnect the intake duct from the throttle body, then remove the duct and MAF sensor from the vehicle.



10. Loosen the screw clamp securing the MAF sensor to the intake duct and remove the sensor. Remove the clamp and rubber seal from the sensor. **CAUTION: The sensor is delicate!** Handle it with care, and place it in a safe location until reinstallation.



11. Remove the airbox by grasping its inboard side, lifting straight up (to release the mount pins from their rubber grommets), and sliding the airbox inboard to release it from its shelf.

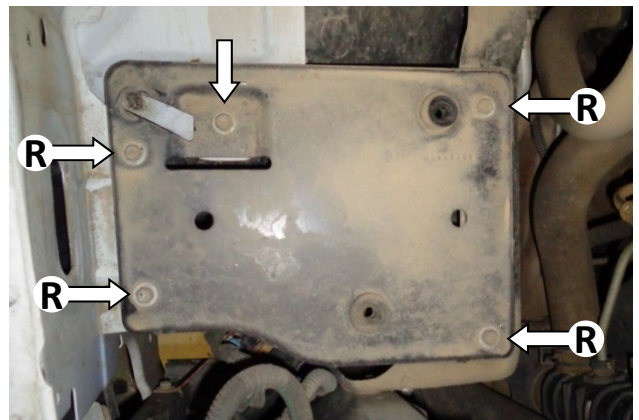

12. Remove the airbox shelf by removing its 5 mount bolts. Retain the 4 bolts marked "R" above. **NOTE: To maintain proper hardware clearances at installation (see Step 15), note the length of the bolts removed from these locations.**



**ASSEMBLE AND INSTALL YOUR FLOWMASTER COLD AIR INTAKE SYSTEM:**



13. Attach the gasket (4) to the heat shield (5) along the edges shown. Starting at one end, press the seal fully onto the edge, gradually working around the heat shield. When you reach the end point, trim the gasket to fit using metal-cutting shears.

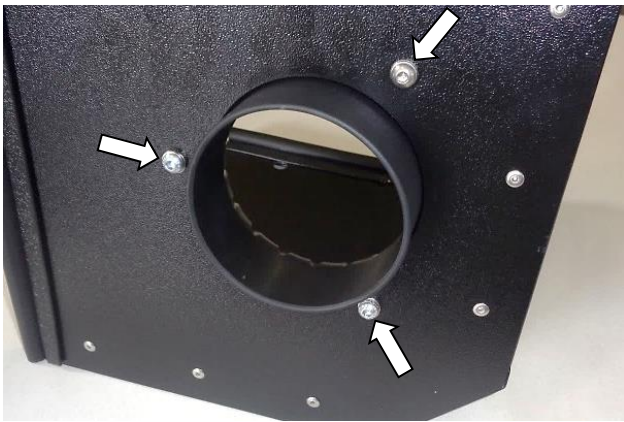

14. Attach air filter adapter (3) to heat shield using M6 screws (8), lock washers (7) and flat washers (6).

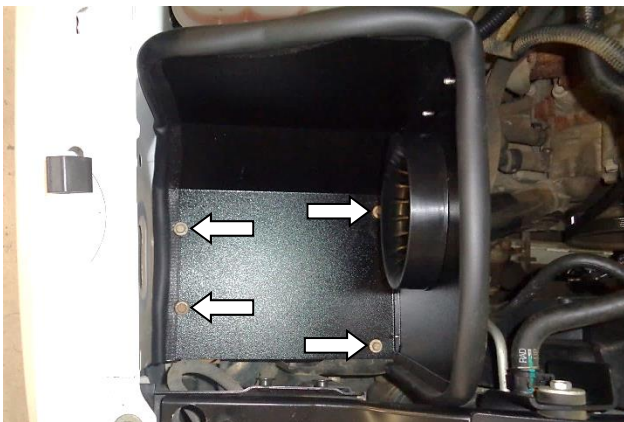

15. Use the 4 bolts removed at Step 12 to install the assembled heat shield in the vehicle. **NOTE: Be sure to use the correct length bolt at each location, as determined at Step 12.**



16. Slip 2 screw clamps (10) onto a straight coupler (9). Install the coupler on the filter adapter, pushing it flush against the heat shield. Tighten only the filter adapter clamp – leave the other clamp loose.

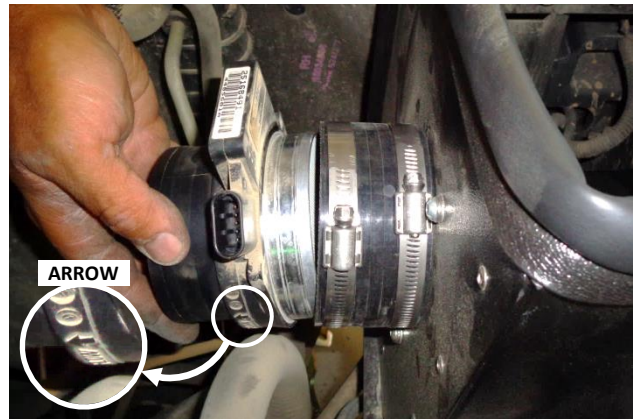

17. Install the MAF sensor in the coupling so that the airflow arrow points away from the heat shield. Push the sensor fully into the coupler, then tighten the clamp.



18. Slip 2 screw clamps (10) onto a flex coupler (11). Install the coupler on the MAF sensor, pushing it flush against the sensor. Tighten only the sensor clamp – leave the other clamp loose.





19. Slip 2 screw clamps (10) onto straight coupler (9) and install the coupler on the throttle body end of the intake tube (12). Only snug the clamp on the tube, and leave the other clamp loose.



22. Adjust the intake tube so that it is properly aligned in each coupling, then tighten the last two screw clamps.



20. Install the intake tube in the vehicle.

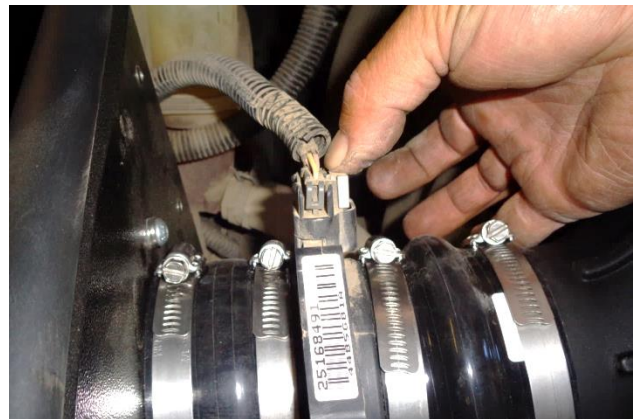

23. Connect the MAF sensor plug to the sensor, close the locking tab, and verify the connection is secure.



21. Push the coupler fully on to the throttle body and tighten only the throttle body clamp.

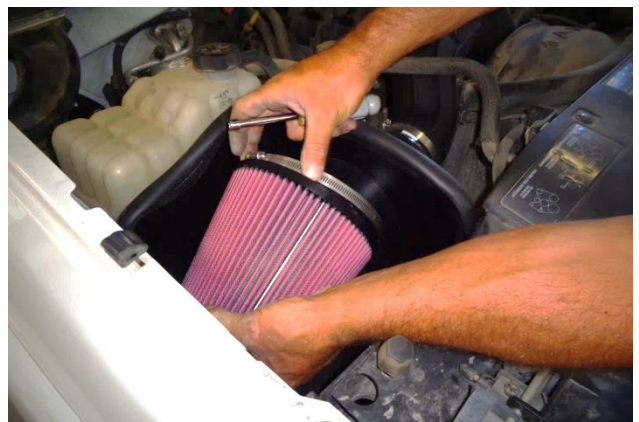

24. Slip screw clamp (2) onto air filter (1), install the filter on the filter adapter, and tighten the clamp.



25. Install the engine appearance cover.



**Congratulations, the installation of your FLOWMASTER cold air intake kit is now complete!**