



## Installation Instructions

# 615138

### 2016-18 CHEVROLET SILVERADO 2500HD & GMC SIERRA 2500HD TRUCKS 6.0L ENGINE

This kit is not engineered to fit vehicles with a body lift.  
**NOT LEGAL FOR SALE OR USE ON ANY POLLUTION-CONTROLLED MOTOR VEHICLE IN CALIFORNIA OR IN STATES THAT HAVE ADOPTED CALIFORNIA EMISSION PROCEDURES.**



Watch our  
 installation video  
 on YouTube

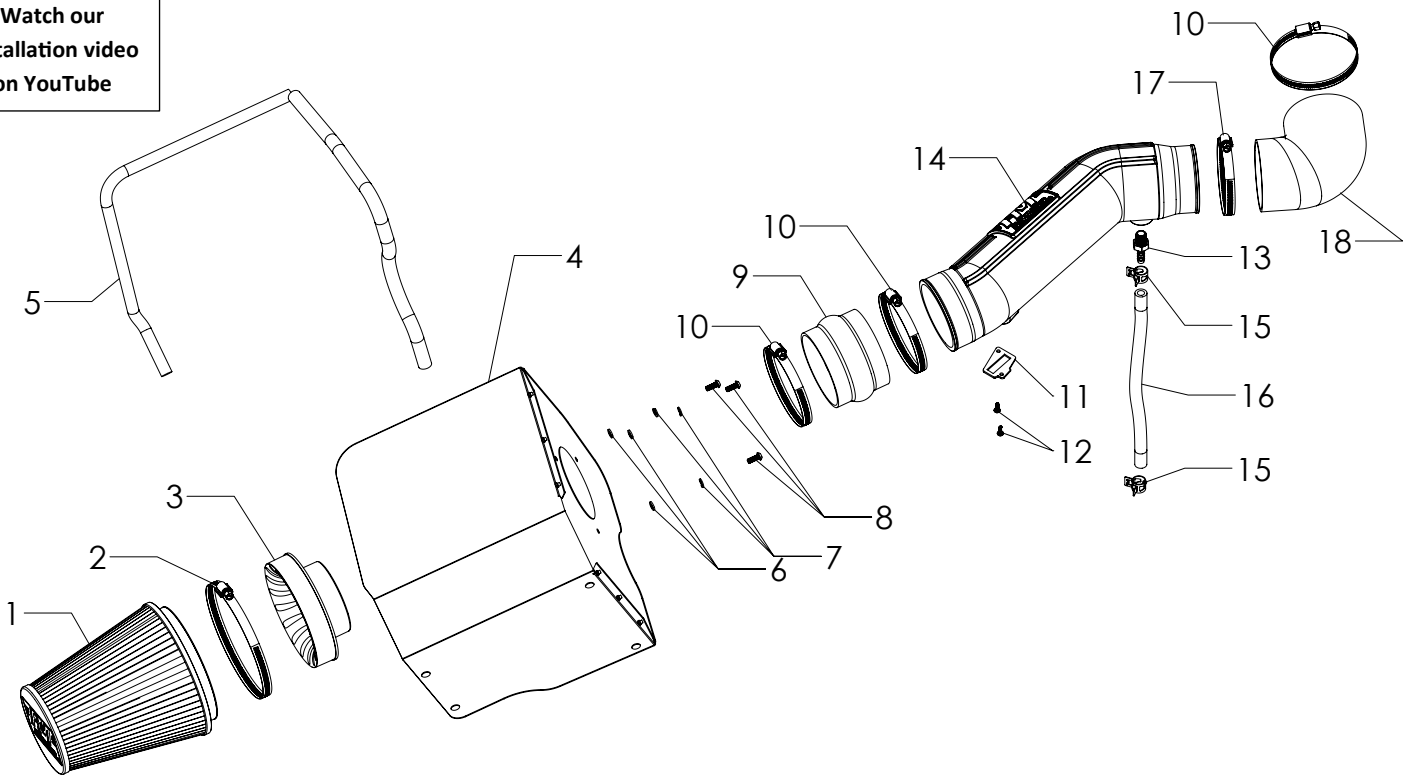

REV 2/4/2020

ITEM NO.	PART NUMBER	DESCRIPTION	QTY.
1	AF1001	AIR FILTER, 8-5/8" x 6" DIA	1
2		SCREW CLAMP, #104 (4-1/8" - 7")	1
3	AF6002	ADAPTER, AIR FILTER 4" x 6"	1
4	AF3009	HEAT SHIELD	1
5	49000061	GASKET, HEAT SHIELD	54"
6	HW319	FLAT WASHER, M6	3
7	HW318	LOCK WASHER, M6	3
8	HW244	SCREW, M6 x 1.0 x 16MM	3
9	AF4005	COUPLER, FLEX 4" I.D. x 3" L	1

ITEM NO.	PART NUMBER	DESCRIPTION	QTY.
10	MC400H	SCREW CLAMP, #64 (3-9/16" - 4-1/2")	3
11	GA139	GASKET, MAF SENSOR	1
12	HW248	SCREW, M4 x 0.7 x 12MM	2
13	AF4040	STRAIGHT FITTING, 3/8" BARB TO 1/4" NPT MALE	1
14	AF2009	INTAKE TUBE	1
15	MC002P	PINCH CLAMP, 3/8" HOSE	2
16	49000065	HOSE, 3/8" I.D.	12"
17	MC350H	SCREW CLAMP, #56 (3-1/16" - 4")	1
18	AF4022	COUPLER, 90 DEG 3-7/8" I.D. x 3-1/2" I.D.	1

## REVIEW THE INSTRUCTIONS AND VERIFY THE KIT CONTENTS:

1. Please take a moment to read and understand these instructions before installing your Flowmaster cold air intake kit.



2. Use the parts drawing and list (front page) to verify your kit's contents.

In the unlikely event that any parts are missing, please contact FLOWMASTER Technical Support for replacements.

---

## REMOVE THE FACTORY AIR INTAKE SYSTEM:

### NOTES

- We highly recommend that you retain all factory air intake system parts.
- Please refer to vehicle manufacturer's recommendations regarding removal of factory components.
- Disconnecting the negative battery cable erases pre-programmed electronic memories. Write down all memory settings before disconnecting the negative battery cable. Some radios will require an anti-theft code to be entered after the battery is reconnected. The anti-theft code is typically supplied with your owner's manual. In the event your vehicle's anti-theft code cannot be recovered, contact an authorized dealership to obtain your vehicle's anti-theft code.

3. Turn off the vehicle's ignition and disconnect the negative battery cable.



4. Remove the engine appearance cover.



5. Loosen the screw clamp securing the intake duct to the throttle body.

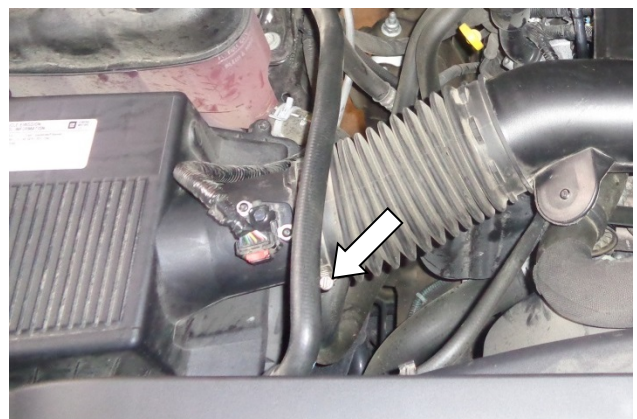

6. Loosen the screw clamp securing the airbox to the intake duct.





7. Disconnect the PCV tube from the left side of the air duct by pulling it straight outward.

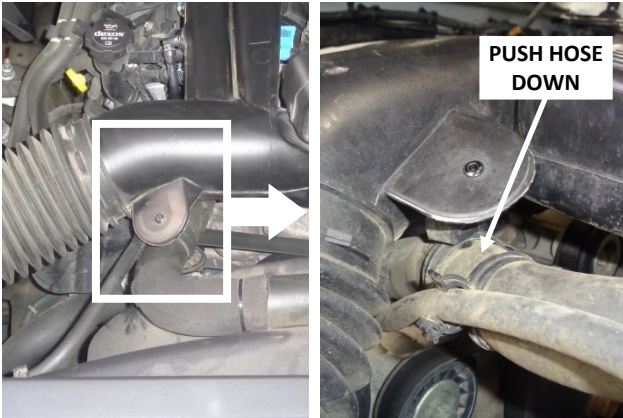

8. Separate the hose clamp from the intake duct by carefully pushing down on the large coolant hose.



9. Separate the intake duct from the airbox and throttle body, and remove the duct from the vehicle.

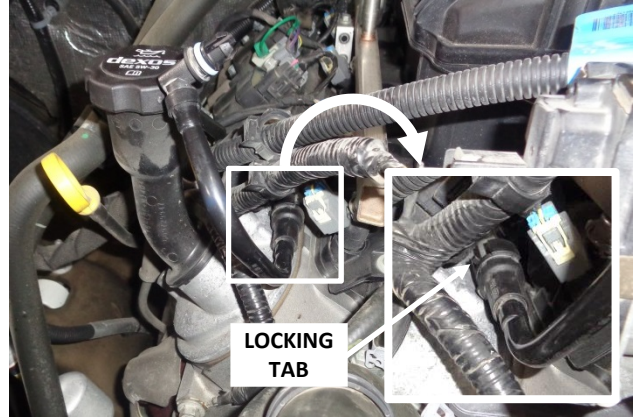

10. Remove the PCV tube from the engine end by releasing the locking tab and pulling the line straight off.

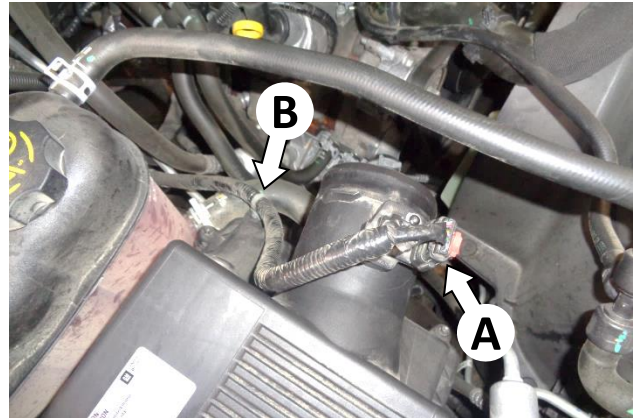

11. Disconnect the electrical plug from the Mass Airflow (MAF) sensor (A) by pulling the locking tab away from the sensor and pulling the plug straight off. Disconnect the MAF sensor lead clip (B) from the airbox.



12. Remove the airbox by lifting up its inboard side (to release the mount pins from their rubber grommets), then sliding the airbox inboard (to release it from its shelf).





13. Remove the MAF sensor from the airbox, then remove the sensor gasket. **CAUTION: The sensor is delicate!** Handle it with care, and keep it in a safe location until reinstallation.

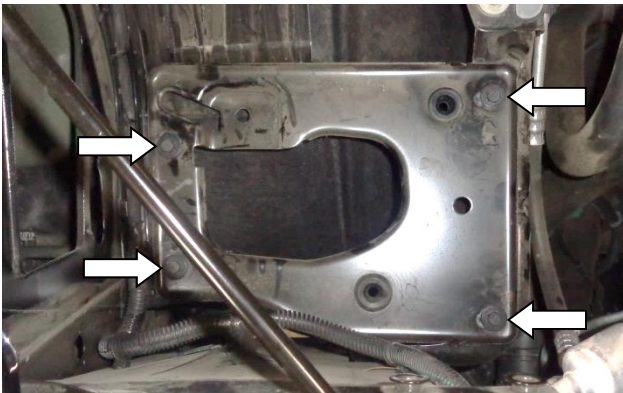

14. Remove the airbox shelf by removing its 4 mount bolts. Retain the bolts for reinstallation at Step 17. **NOTE: If the bolts are different lengths, note the length of each bolt and its location, to maintain proper bolt clearances at reinstallation.**

**ASSEMBLE AND INSTALL YOUR FLOWMASTER COLD AIR INTAKE SYSTEM:**

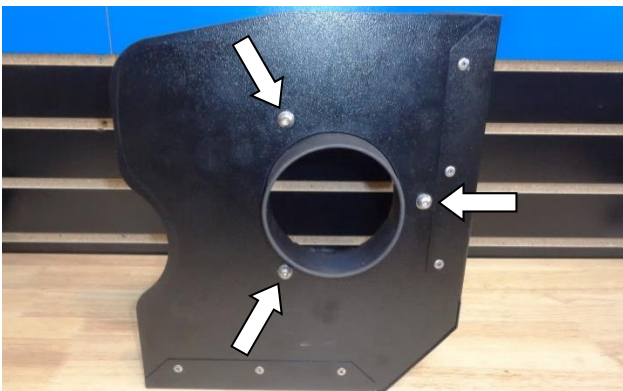

15. Assemble the air filter adapter (3) to the heat shield (4) using the M6 screws (8), lock washers (7) and flat washers (6).

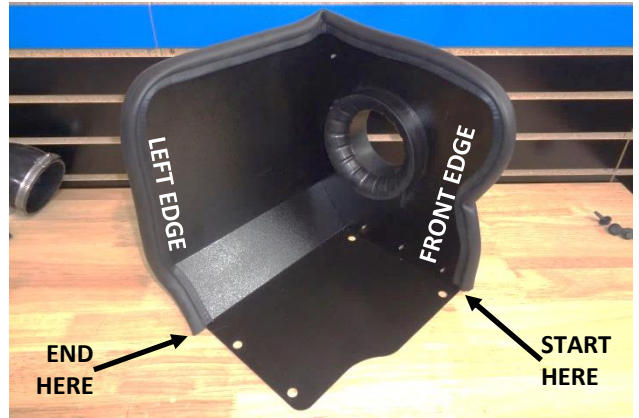

16. Attach the gasket (5) to the heat shield. Starting at the bottom of the front edge, firmly press the seal onto the edge, gradually working your way around. At the bottom of the left edge, use metal-cutting shears to trim the seal to fit.

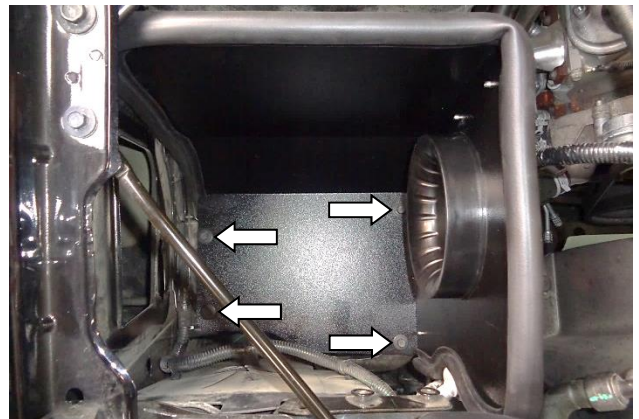

17. Use the 4 bolts removed at Step 14 to install the assembled heat shield in the vehicle. **NOTE: If the bolts are different lengths, be sure to use the correct length bolt at each location, as determined at Step 14.**



18. Apply 2 wraps of nylon thread tape to threads of the 3/8" barbed fitting (13), and install it in the intake tube (14).





19. Install MAF sensor gasket (11) on the sensor, ensuring correct orientation. Then install sensor in intake tube, using M4 screws (12).



20. The kit includes three large screw clamps (10) and one small clamp (17). Install two large screw clamps on the flex coupler (9), and install the coupler on the filter end of the intake tube. Snug (but do not yet tighten) just the clamp on the tube, and leave the other clamp loose.



21. Install the small screw clamp (17) on the elbow coupler (18), install the coupler on the other end of the tube, and snug (but do not yet tighten) the clamp. Then slip the last large screw clamp on the other end of the coupler, but do not tighten it yet.



22. Install the intake tube in the vehicle.

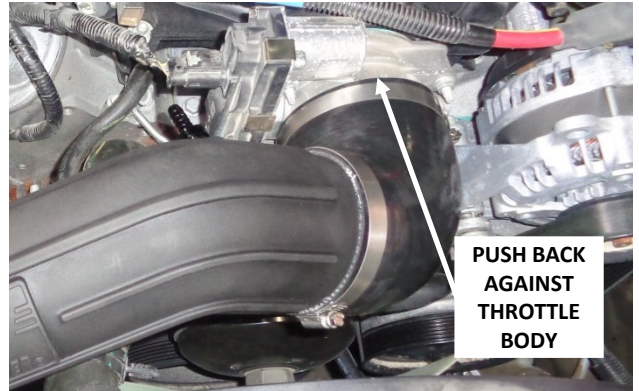

23. Push the elbow coupler back against the stops on the throttle body, and tighten only the throttle body clamp.

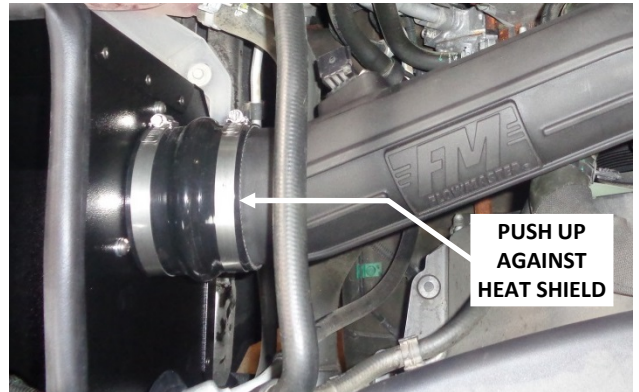

24. Push the flex coupler up flush against the heat shield, and tighten only the filter adapter clamp.



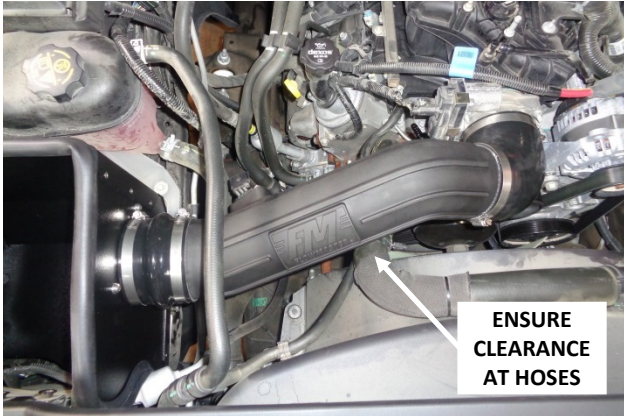

25. Center the tube between the couplers, and rotate it if necessary to avoid contact with any hoses. Then tighten the two tube clamps.

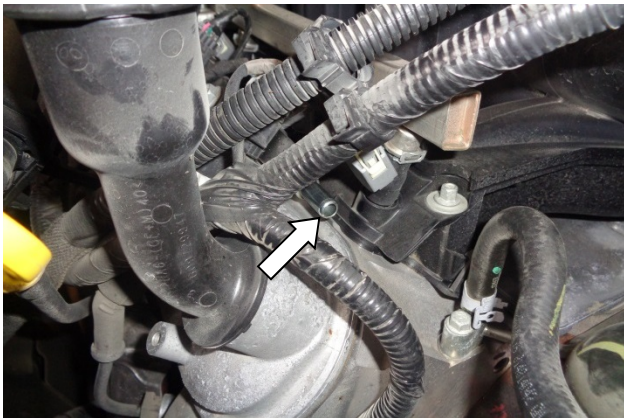

26. Secure one end of the 3/8" hose (16) to the engine PCV tube with a pinch clamp (15).



27. Cut the hose to length, and secure the other end to the barbed fitting with the other pinch clamp (15).

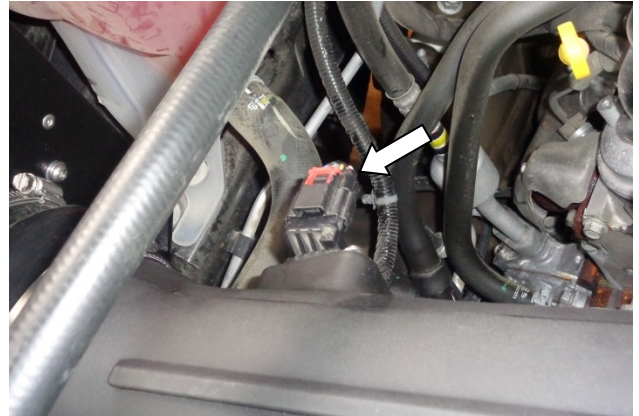

28. Push the MAF sensor plug onto the sensor until it clicks, then verify the connection is secure.

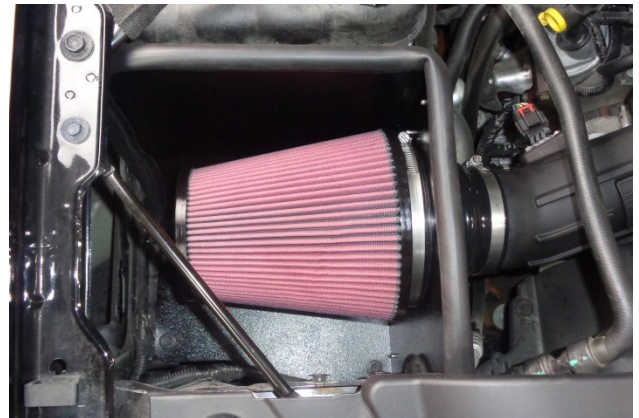

29. Slip screw clamp (2) onto air filter (1), install the filter on the filter adapter, and tighten the clamp.



30. Install the engine appearance cover.

**Congratulations, the installation of your FLOWMASTER cold air intake kit is now complete!**